

WP-Sinewave Inverter with Transfer Switch



Generating Confidence

WhisperPower BV | Kelvinlaan 82 | 9207 JB Drachten | The Netherlands

Tel: +31 (0) 512 571 550 | E-mail: sales@whisperpower.com | whisperpower.com

For safe and optimum performance, the WhisperPower Sinewave Inverter with Transfer Switch must be used properly. Carefully read and follow all instructions and guidelines in this manual and give special attention to the **CAUTION** and **WARNING** statements.

PLEASE KEEP THIS MANUAL FOR FUTURE REFERENCE

Disclaimer

While every precaution has been taken to ensure the accuracy of the contents of this guide, WhisperPower assumes no responsibility for errors or omissions. Note as well that specifications and product functionality may change without notice.

Important

Please be sure to read and save the entire manual before using your WhisperPower Sinewave Inverter with Transfer Switch unit. Misuse may result in damage to the unit and/or cause harm or serious injury.

Product Numbers:

61123501 WP-Sine XFR12/3000i-UK Sinewave Inverter 3000W with Transfer Switch (British Socket)
61123500 WP-Sine XFR12/3000i-EU Sinewave Inverter 3000W with Transfer Switch (Schuko Socket)

For more information, or to order documents, contact:

WhisperPower b.v.
Kelvinlaan 82
9207 JB Drachten
The Netherlands

Table of Contents

1.	INTRODUCTION	4
2.	PRODUCT DESCRIPTION	6
3.	INSTALLATION	7
4.	UNIT OPERATION	13
5.	FEATURE SETTING	15
6.	TROUBLESHOOTING	18
7.	SPECIFICATIONS	22
8.	WARRANTY	23
9.	CERTIFICATE OF CONFORMITY	24
	APPENDIX I	25
	APPENDIX II	26

1. INTRODUCTION

Thank you for purchasing the WhisperPower Sinewave Inverter with Transfer Switch unit. With our state of the art, easy-to-use design, this product will offer you reliable service by providing AC power and 5V USB power for your home, cabin, boat, RV, Caravan or Trailer using battery power. The Sinewave Inverter can run many AC-powered appliances when you need AC power from a battery source. The 5V USB power can charge many USB-powered devices. The inverter also will automatically switch to utility AC power when it is available at your home, dock or campsite.

This manual will explain how to use this unit safely and effectively. Please read and follow these instructions and precautions carefully.

IMPORTANT SAFETY INFORMATION

This section contains important safety information for the Sinewave Inverter. Before using the unit, READ ALL instructions and cautionary markings on or provided with the unit, and all appropriate sections of this guide.

The Sinewave Inverter contains no user-serviceable parts. See Warranty section for how to handle product issues.



DANGER: Fire and/or Chemical Burn Hazard.

Do not cover or obstruct any air vent openings and/or install in a zero-clearance compartment.



DANGER: Failure to follow these instructions can result in death or serious injury.

When working with electrical equipment or lead acid batteries, have someone nearby in case of an emergency.

Study and follow all the battery manufacturer's specific precautions when installing, using and servicing the battery connected to the inverter. Wear eye protection and gloves. Avoid touching your eyes while using this unit. Keep fresh water and soap on hand in the event battery acid comes in contact with eyes. If this occurs, cleanse right away with soap and water for a minimum of 15 minutes and seek medical attention.

Batteries produce explosive gases. **DO NOT smoke** or have an open spark or fire near the system. Keep unit away from moist or damp areas.

Avoid dropping any metal tool or object on the battery. Doing so could create a spark or short circuit which goes through the battery or another electrical tool that may create an explosion.



DANGER: Shock Hazard. Keep away from children!

Avoid moisture. Never expose unit to snow, water etc.

Unit provides household AC output; treat the AC output socket the same as regular wall AC sockets at home.

**DANGER: Explosion hazard!**

DO NOT use the unit in the vicinity of flammable fumes or gases (such as propane tanks or large engines). AVOID covering the ventilation openings. Always operate unit in an open area. Prolonged contact to high heat or freezing temperatures will decrease the working life of the unit. DO NOT connect AC power source like utility power or generator to the AC outputs of the unit. It will damage the unit and may cause fire. Feeding AC to the AC output of the unit is not covered by warranty.

FCC and CE EMC INFORMATION

This equipment has been tested and found to comply with the limits for a Class B digital device, pursuant to part 15 of the FCC Rules on 120V model and comply with the limits for CE EMC Standard on 230V model. These limits are designed to provide reasonable protection against harmful interference in a residential installation. This equipment generates uses and can radiate radio frequency energy and, if not installed and used in accordance with the instructions, may cause harmful interference to radio communications. However, there is no guarantee that interference will not occur in a particular installation. If this equipment does cause harmful interference to radio or television reception, which can be determined by turning the equipment off and on, the user is encouraged to try to correct the interference by one or more of the following measures:

- Re-orient or relocate the receiving antenna.
- Increase the separation between the equipment and the receiver.
- Connect the equipment into an outlet on a circuit different from that to which the receiver is connected.
- Consult the dealer or an experienced radio/TV technician for help.

LIMITATIONS ON USE

Do not use in connection with life support systems or other medical equipment or devices.

2. PRODUCT DESCRIPTION

The WhisperPower Sinewave Inverter includes the items list below.

- Inverter with transfer switch base unit with detachable Remote Panel
- Remote Panel Cable
- Owner’s Manual

Series	Model No.	Rating		AC Output Types
		Inverter	Transfer Switch	
230 VAC	WP-Sine XFR12/1000i	1000W	16A	16A (EU-Schuko), Hardwire 13A (UK-British), Hardwire
	WP-Sine XFR12/2000i	2000W		
	WP-Sine XFR12/3000i	3000W		

3. INSTALLATION

WARNING: All wiring should be done by a certified technician or electrician to ensure adherence to the applicable electrical safety wiring regulations and installation codes. Failure to follow these instructions can damage the unit and could also result in personal injury or loss of life.



CAUTION: Before beginning unit installation, please consider the following:

The unit should be used or stored in an indoor area away from direct sunlight, heat, moisture or conductive contaminants.

When placing the unit, allow a minimum of three inches of space around the unit for optimal ventilation.

Understanding the unit features

AC Output Front Panel

AC Wiring Compartment:

- Hard Wired AC Output Port 2
- Ground Port GP1 & GP2
- AC Output strain relief
- AC Input strain relief
- Common (Input/Output) AC Ground
- AC Input port



- USB Output
- Status Indicator
- Display
- On/Off button
- Thermal breaker for AC Output socket
- Select button
- AC Output Socket

Model XFR12/3000i UK

AC Wiring Compartment:

- Hard Wired AC Output Port 2
- Ground Port GP1 & GP2
- AC Output strain relief
- AC Input strain relief
- Common (Input/Output) AC Ground
- AC Input port

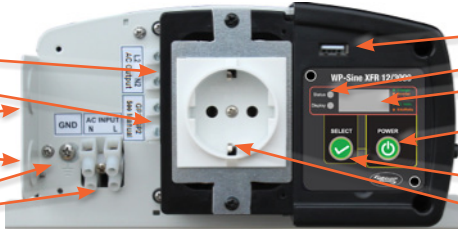

- USB Output
- Status Indicator
- Display
- On/Off button
- Thermal breaker for AC Output socket
- Select button
- AC Output Socket

Model XFR12/3000i EU

DC Input Rear Panel

Fan Opening



DC Input Terminals

Model WP-Sine XFR12/3000i rear side

Preparing for Installation

Typical Wiring block diagram of the Power Inverter:

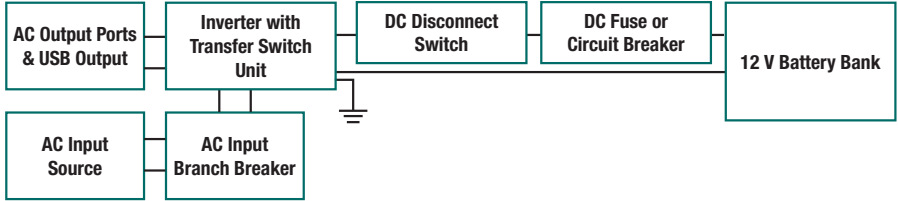

12V Battery Bank:

- The use of a deep cycle battery is highly recommended for power inverter application
- For battery sizing, you need to identify what you wish to operate, and for how long. It is recommended that you purchase as much battery capacity as possible. See more on Battery Run Time in Section 4.

DC Fuse or Circuit Breaker:

- DC-rated fuse or DC-rated circuit breaker connected along the DC positive line is required.

	1000W model	2000W model	3000W model
Fuse/Circuit Breaker Rating	150Adc	300Adc	450Adc

- Based on the size of your 12V Battery Bank, determine the overall short circuit current rating of the battery bank from the battery manufacturer. The fuse or circuit breaker chosen has to be able to withstand the short circuit current that may be generated by the battery bank
- For Marine application, the over-current protective device needs to be installed within 7 inches (17.8cm) from the battery positive terminals.

DC Disconnect Switch:

- Use a DC Disconnect Switch with the same or higher rating of the selected fuse or circuit breaker. Use ignition protected switches when required by local codes.
- The DC Disconnect Switch is used to disconnect the DC power between the unit and the battery bank during service, maintenance or trouble shooting.

DC Input Cable Size:

All DC cables require insulated multi-strand low resistance cable. The DC cables must be copper and must be rated 105° C minimum.

Model	Minimum Wire Size	Recommended Cable Length
1000W unit	AWG # 2	< 5 feet
2000W unit	AWG # 2/0	< 5 feet
3000W unit	AWG # 4/0	< 5 feet



Caution: Use of smaller gauge cable or longer cable length may cause the inverter to shutdown under heavy load and may also melt the cable insulation and catch fire and can result in death or serious injury. Choose of the cable size should also match with the rating of the DC fuse used.

Important: The recommended cable length is limited to < 5 feet. This is due to the consideration of voltage drop between the battery and the unit. Change to use a bigger size cable is needed if long cable length is used.

Grounding Cable Size:

Important: The unit is grounded through the ground stud located near the DC Input terminal and the chassis of the unit has to be grounded properly before use.

- For Marine application, the DC grounding cable size may be one size smaller than the minimum size conductor required for the DC current-carrying conductors and the conductor is no smaller than #10 AWG.
- For Recreational Vehicle or Caravan application, the unit has to be grounded to the vehicle chassis with a minimum #8 AWG copper conductor.

AC Input Source and AC Branch Breaker:

- Standard AC Input wire is required for all the AC connections between the AC source & the AC Input port, and the AC Output ports to load.
- For 230V model and maximum By-Pass power rating, a minimum of #14 AWG AC wire is required. A 16A branch circuit breaker is also required to connect between AC Input source and unit's AC Input port.

Important: Follow the electrical and/or building code when you connect the unit to any AC source.

Installing the Inverter System



WARNING: Electrical Shock Hazard

The unit 'On/Off' switch does not disconnect the DC power from the battery. Use the DC Disconnect Switch or disconnect the DC input cables to disconnect the DC power from the battery before working on any circuits connected to the unit. Failure to follow these instructions can result in death or serious injury.

Installation:

- Choose an appropriate mounting location.
- For indoor use, the unit can be mounted in any direction except with the DC Input panel facing downwards.
- Use the mounting template below to mark the positions of the mounting screws.
- Drill the 4 mounting holes and place the Inverter in position and fasten the unit to the mounting surface.

Important: Field wiring DC terminals tightening torque 12-13 Nm

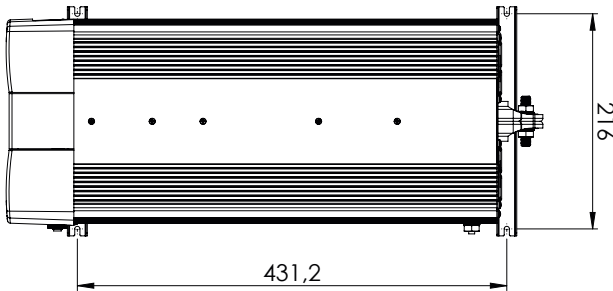

WP-Sine XFR 12/3000

Chassis Grounding Connection:



DANGER: The unit chassis has to be grounded properly. Never operate the Inverter without proper grounding. Failure to do so will result in death or serious injury.

Connect the grounding cable's ring terminal to the unit ground screw.

Connect the other side of the cable to the common grounding point.

DC Input Connection:**CAUTION: Reversing the DC Input terminal will damage the unit and it cannot be repaired.****Damage caused by reverse polarity connection is not covered by the warranty.**

- Connect the negative DC input cable between the Inverter DC negative terminal and battery negative terminal.
- Make sure the Disconnect Switch is in the OFF position.
- Connect a positive DC input cable between the inverter DC positive terminal and one terminal of the Disconnect Switch.
- Connect another DC input cable between the other terminals of the Disconnect Switch to one side of the terminal of the fuse holder.
- Connect another DC input cable between the other terminal of the fuse holder and the battery positive terminal.
- Install the selected fuse to the fuse holder.

AC Input Connections:

Warning: Please double check the location of the AC input port located inside the wiring compartment. Misconnecting to the AC output port inside the same compartment will blow the unit and may catch fire. Before making any AC input connection, please be sure the AC Input Source is not energized and the DC disconnect switch is OFF.

Important: A Branch Breaker (not provided) is required to connect between the AC source and the AC Input Port of the unit..

Model	AC Input Branch Breaker	AC Input wire
230VAC unit	16A (maximum)	#14 AWG (minimum)*

- Remove the AC compartment cover by unscrewing the four screws located at the front of the AC compartment cover.
- ***Note:** A small size AC Input wire can be used when a smaller amperages rated AC-Input Branch Breaker is used upstream to feed the unit.
- Connect the AC Input 'L' wire between the unit's AC Input Port and the Branch Breaker terminal.
- Connect the AC Input 'N' wire between the unit's AC Input Port and the AC source 'N' terminal.
- Connect the AC Input ground wire to the Common AC Ground connection on the unit. If solid ground wire is used, the wire can be connected directly under the screen head. If stranded ground wire is used, ring terminals must be used.

AC Output Connections:

CAUTION: Please be sure that the AC Input source is not energized before making any Output connection and that the DC disconnect switch is turned OFF.

For 230V model:

The AC Output has two types of AC connections:

1. Use of the provided AC Output Socket for AC load connection:
This configuration does not require AC Output installation. Plug in the AC load to the provided AC Output Socket. During the By-Pass mode, the AC output is limited by the rating of the thermal breaker and the limitation of the AC Output used (16A on -EU model, 13A on -UK model).
2. Use of the provided Hardwire AC Output terminal (Port 2).
 - To access Port 2, remove AC compartment cover located on the front panel of the unit.
 - Hardwire the AC load or any external AC socket to the AC Output port 2. Please verify the LIVE 'L' and NEUTRAL 'N' connection on the AC Output Port 2.

Important: If a RCD (Residual Current Detector) is used for the AC Output connection, an AWG #14 jumper wire is required to connect between GP1 and GP2. This is used to ground the Neutral pin of the inverter to the chassis.

3. Connect the AC output Ground wire to the Common AC Ground terminal inside the wiring compartment.

Note: During Battery Power Mode, AC output is limited to a total of 4.3A for 1000W model or 8.7A for 2000W model or 13A for 3000W model.

Remote Display Connection:

- The Remote Display on the unit is detachable. To install the remote in a different location, the provided 6 pin standard RJ12 "rollover" cable is used.
- Remove the 2 screws at the front of the Display Panel and disconnect the small RJ12 cable from the unit.
- Install the RJ12 cable in your desired location and connect the RJ12 cable to the unit and the other end of the cable to the Display Panel. Please note polarity.

Test the Inverter Connection:

- Switch DC disconnect switch to ON to provide battery power to the unit.
- Switch the AC Branch Breaker to ON to provide AC Input power to the unit.
- The LED on display will turn on. If AC input source is available, 'Status' LED turns green. This indicates the unit is running in By-Pass mode meaning AC output is running from the AC input source.
- Disconnecting the AC input source by turning OFF the AC Input Branch Breaker will change the 'Status' LED on the display to amber.
- Both AC output and 5V USB are now available and the unit is running on battery power.
- Plug in a small AC load like a 40W table lamp or small appliance to the AC socket to verify AC is available.
- The unit is successfully installed and functioning properly.

4. UNIT OPERATION

Auto Backup Mode (whatever “PS” setting except “PS0”):

The unit is fully automatic. When utility power is available, the unit is running in AC By-Pass mode. AC output is supplied from the utility. When there is a power failure from the utility or an AC source is not available, the unit will run on battery power and the inverter will generate sinewave AC output to maintain and operate the load continuously (With ‘PS2’ setting, there is a minimum of 10W AC-Load sense threshold for the inverter to fully turn on).

Non-Backup Mode (with “PS0” setting)

Same as Auto Backup Mode but when there is a power failure from the utility or the AC input source is not available; the inverter will not turn ON automatically. To turn on the inverter you are required to get into the setting mode to change the “PS0” setting to “PS1” or others. See more details on Inverter Setting.

Understanding the Display Function:

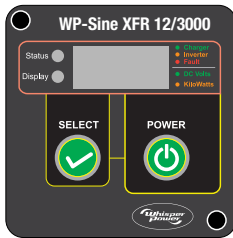

Status LED	Display LED	Display	Function/Status
Green (solid)	Green	'12.5'	By-Pass Mode. Display shows battery voltage in DC volts
Amber (solid)	Green	'12.5'	Battery/Inverter Mode. Inverter is running. Display shows battery voltage in DC volts
	Amber	'0.80'	Battery/Inverter Mode. Inverter is running, Display shows output power in kW (800W as shown)
Amber (flashing)	Battery (Inverter) Mode and AC Input is detected and unit will switch to By-Pass mode within 20 seconds		
Red (solid)	OFF	E01-E12	Unit has shutdown. Display shows error code (See error code reference chart below)

Note: **'Status'** LED is use to indicate the status of the unit.

Green: By-Pass Mode

Amber: Battery (Inverter) Mode

'Display' LED is use to indicate the digital display function.

Green: Display is showing Battery voltage in volts.

Amber: Display is showing Output power in KW.

Understanding the 'Power' and 'Select' push button function during normal operation

A beep sound will occur every time when the **'Power'** or **'Select'** button is triggered.

'Power' button function:

- Turns the inverter On/Off during Battery Mode. Press and hold it for 1 second to turn the unit either ON or OFF.

Note: The **'Power'** button can be used to turn the AC Output OFF during AC By-Pass mode with 'PS4' setting without the need to disconnect the AC-Input as per "PS1" setting. See more on "Understanding the unit setting".

'Select' button function:

Check the unit setting: Press once to check or verify unit's present set functions

Understanding the Error Code

Code	Condition	Corrective Action
E01	When unit is in Battery (Inverter) mode, Input battery voltage is too low and AC Output is shutdown. When unit is in By-Pass Mode the unit continues supplying AC-Output power.	Recharge the battery immediately and restart unit. Make sure the battery is connected to the unit. Check the battery is connected to the unit. Although the unit still provides AC Output power from Utility, recharge the battery ASAP.
E02	Input battery voltage is too high and unit has shutdown	Check battery voltage or determine if any external charger is connected to the battery bank
E03	AC output is overloaded or short circuited and unit has shutdown	Check load connected to the output. Reduce load and restart the unit
E04	Internal temperature is too high and unit has shutdown	Turn unit off and wait for 15 minutes before restarting. Check if any object has blocked the air flow of the unit
E05	Input battery voltage is low and warning occurs	Recharge battery as unit will shutdown shortly
E06	At Battery Mode, AC output load connected has been sensed high and is close to shutdown limit	Reduce load
E07	Internal temperature is high and is close to shutdown limit	Reduce load and check if any ventilation of the unit is blocked
E08-11	Not used	
E12	Internal transfer switch temperature is high and shutdown occurs	Reduce load and check if any ventilation of the unit is blocked

AC Load on Inverter

Although the Power Inverter can provide high surge power up to two times the rated output power, some high surge loads like sump-pumps, heavy duty motors etc. may still trigger the inverter protection system even though the load falls within the power rating of the inverter. A higher power Inverter is required for these appliances.

Estimated Run Time

Following run times are estimates for reference, based on using different battery bank sizes. Actual run times may vary.

Important: Power Drain from DC Battery Bank.

Please note that there is a power drain of 700mA from the battery bank when the WP-Sine XFR12/3000 or WP-Sine XFR12/3000i is running in AC By-Pass mode. In order to avoid draining down the battery bank, a battery charger with sufficient power is required to maintain the battery bank voltage.

AC Load	Estimate run time on different 12V Battery Bank Size				
	60AH	120AH	180AH	240AH	300AH
50 W	11 hrs.	22 hrs.	33 hrs.	44 hrs.	55 hrs.
100 W	5 hrs.	11.5 hrs.	17 hrs.	23 hrs.	29 hrs.
200 W	2.5 hrs.	5 hrs.	8 hrs.	11 hrs.	13.5 hrs.
500 W	49 mins	2 hrs.	3 hrs.	4 hrs.	5 hrs.
1000 W	15 mins	49 mins	1.5 hrs.	2 hrs.	2.5 hrs.
1500 W	8 mins	27 mins	49 mins	1 hr	1.5 hrs
2000 W	N.R.	15 mins	34 mins	49 mins	1 hrs
2500 W	N.R.	11 mins	25 mins	37 mins	49 mins
3000 W	N.R.	N.R.	17 mins	27 mins	37 mins

Note: N.R. - Not Recommended

5. FEATURE SETTING

To understand more about the unit features, read the following section and follow the instructions to make changes to the desired setting.

Default Factory Setting:

- PS (Inverter): PS1 - Inverter enabled in standby mode with load sense off
- AL (Alarm): AL1 - Alarm enabled
- Sd (UV shutdown): SdL - Under voltage shutdown set to low setting

Understanding the Unit Settings

Inverter Setting	
PS0	<p>Inverter is disabled, AC Output is getting the power from utility (AC Input) only. But when utility power is not available, the unit will not provide AC backup function from the inverter, the display automatically turns off in about 10 seconds. When the Power button is pressed again, the display will turn on for another 10 seconds.</p> <p>To enable the inverter or turn on the backup function, this PS0 setting has to be changed to other different setting.</p>
PS1	<p>Inverter is set to standby condition with power save (load sense) mode OFF. Unit will provide AC backup function when utility power is not available</p>
PS2	<p>Inverter is set to standby mode with power save (load sense) mode ON. Unit will provide continuous AC backup function only when utility power is not available AND the load connected to the output is >10W. Once it is ON, the unit will automatically return to power save (load sense) mode when the connected AC load drops to < 3W.</p> <p>Note: During power save mode, the Inverter will turn ON every few seconds for a few AC cycle to check on the 10W power consumption.</p>
PS3	Not Used
PS4	<p>Same function as PS1 and the 'Power' button can be used to turn the AC Output ON and OFF, even with the AC-Input power being present in By-Pass mode. When the unit is turned off using the 'Power' button, the display remains ON showing the battery voltage and the 'Status' LED will turn off.</p>
Battery Under Voltage Setting	
SdL	<p>Battery under-voltage setting is set to LOW (setting used for normal operation)</p> <ul style="list-style-type: none"> Under-voltage alarm: 11.0 Vdc Under-voltage alarm recovery: 11.3 Vdc Under-voltage shutdown: 10.5 Vdc Under-voltage shutdown recovery: 12.0 Vdc
SdH	<p>Battery under-voltage setting is set to HIGH (setting to avoid battery over discharge when connected to car start battery)</p> <ul style="list-style-type: none"> Under-voltage alarm: 12.1 Vdc Under-voltage alarm recovery: 12.3 Vdc Under-voltage shutdown: 11.8 Vdc Under-voltage shutdown recovery: 12.6 Vdc

Alarm Setting

ALO	Fault and the warning audible alarm is disabled. The display panel only shows error code and the audible alarm will not sound.
AL1	Audible alarm will sound when fault or warning occurs.
Manufacturing Default	
Fd	Reset all the settings to the manufacturing default settings (PS1, SdL, AL1)

Enter the Function Menu for unit setting:

To enter the unit Function Menu, press and hold **“Power”** and **“Select”** buttons together for about 5 seconds until a beep is sounded.

When you are in Function Menu:

- Press 'Power' button for 1 second to toggle between different Functions Menu like 'In', 'Sd', 'AL', and 'Fd' etc.
- Press 'Select' button for 1 second to enter Individual Function Set Menu and you can make changes to the settings.
- The unit will EXIT the Main Menu automatically if 'Power' and 'Select' buttons are not triggered for more than 5 seconds.

When you are in Individual Function Set Menu:

- Press 'Select' button for 1 second to toggle between different setting values.
- Press 'Select' button for 5 seconds to set selected setting and exit to next Main Menu

See more details on flow chart in Appendix I.

6. TROUBLESHOOTING

To troubleshoot the unit, please note the error code displayed on the main unit and review “Understanding the Error Codes” in section 4.

Problem	Possible Cause/Condition	Solution
No AC Output. All the LEDs and the display are off.	The unit is off Note: The power button On/Off action takes place at its release moment and after a “beep” is heard	Turn the unit ON by pressing the “Power” button (when the unit is in Battery/inverter mode, or in By-Pass mode if the PS4 parameter is set) otherwise the unit should always turns on automatically at the moment the AC-Input power is connected.
	No power coming into the unit	Check the battery DC fuse, the Disconnect Switch (if installed), the AC Input Source and the AC Input Branch Breaker is either tripped or turned OFF
No AC output on the AC Output Socket (230V model). Status LED is Green or Amber ①	The unit’s thermal breaker is tripped	Check loads and reset the thermal breaker
AC Output turns ON and OFF.	Power Safe mode (“PS2”) enabled and AC load <10W	The load connected must be below the AC load sense threshold of 10W +/-25%
No AC Output. Status LED is red	The unit had shutdown, check Error code shown on display.	Verify the error condition and make correction
During AC Input Power Outage, there is no AC Output power when battery power is available.	The unit is set to “Non-Backup” mode (“PS0”) and AC Input Power is not available.	Change the “PS0” setting to a different setting if you wants to turn the inverter ON. With “PS0” setting, the inverter is completely OFF. When the AC Input Power is not available and the “Power” button is press once, the display and LEDs stay working for about 30 sec only. With this setting, the unit will provide AC Output Power only when the AC Input Power is available.
AC Output only in Hardwire Port 2 (230V model)	Same as in ①	AC Output Port 2 on 230V model is connected directly to the inverter output. This Port is not under the tripping influence of the thermal breaker on the unit.

Problem	Possible Cause/Condition	Solution
<p>“E01” or “E05” alarm in By-Pass (pass-through) mode WP-Sine XFR 12/1000 12/2000 12/1000i 12/2000i only) ②</p>	<p>The unit is normal. The alarms indicate the battery voltage is low or the battery is not connected. There may be an external DC loads connect to the DC input terminals and it draws currents from the current-limited built-in trickle battery charger. However the unit <u>continues</u> supplying AC-Output power in despite of those alarms</p>	<p>Charge and/or connect the battery bank or disable all the audible alarms with the “ALO” setting when AC backup is not required.</p> <p><u>Note:</u> The main purpose of the internal trickle battery charger is to keep the unit’s control electronics working and can still provide AC Out when utility is available even without the battery connected. It is not intended to act as a real trickle charger for your battery bank. Therefore do not rely on this small tickle charger as a source to charge your battery bank.</p>
<p>DC voltage is measured at the DC terminals without the battery being connected (WP-Sine XFR 12/1000 12/2000 12/1000i 12/2000i only)</p>	<p>This is normal. The voltage is supplied by a little built-in trickle battery charger with current limiting protection.</p>	<p>You can keep the battery disconnected. However if the DC-Input terminals of the unit are connected to a common DC bus being shared by other DC loads, a 12V back feeding to those DC loads can occurs when the DC bus is disconnected from the common battery bank. In that case the corresponding drawing current may trigger the “E01” or “E05” alarms as per the problem ②. In cases where that back feeding is not desirable, consider using a separate battery bank disconnect switch for the unit</p>
<p>No AC Output. All the LEDs and the display are off even in By-Pass mode (WP-Sine XFR 12/3000 only)</p>	<p>WP-Sine XFR12/3000 requires a battery connected to the DC input terminals to maintaining the unit working properly.</p>	<p>Keep the battery connected to allow the unit working properly.</p> <p>On the other hand and as a consequence of that, there is a power drain of about 700mA from the battery bank when the WP-Sine XFR12/3000 is running in AC By-Pass mode. In order to avoid draining down the battery bank in the medium-long term, a battery charger or trickle charger with a minimum of 1A is required to maintain the battery bank voltage.</p>
<p>The unit’s thermal breaker trips even when the unit is out of an overload condition</p>	<p>This happens mainly in By-Pass mode when the maximum rating of the unit’s breaker is exceeded. In the WP-Sine XFR12/3000 unit that rating can be exceeded in Battery (Inverter) mode as well.</p>	<p>In the 230V model: for maximum capacity use the AC-Output Port 1 which is out of the tripping influence of the unit’s thermal breaker. Otherwise do not exceed 16A/13A/10A on the AC outlets in the EU/UK/AU models respectively.</p>

Problem	Possible Cause/Condition	Solution
<p>The unit cannot be turned off using the power button when in “By-Pass” mode</p>	<p>This is normal. The unit has “PS1” (factory default) setting. Use the procedure on the right to turn off the unit.</p>	<p>To turn the unit off while in By-Pass (pass-through) mode, first of all disconnect the AC-Input that feeds the unit to force entering into Battery (inverter) mode. Then push and hold the power button for 1 sec. (after hearing a beep) to turn the unit off.</p>
	<p>Note: The power button On/Off action takes place at its release moment and after a “beep” is heard</p>	<p>Set unit to PS4 mode. With this setting, the power button can be used to turn the unit ON and OFF during By-Pass and Battery (inverter) mode.</p>
<p>The input battery under-voltage warning (“E05”) and/or shutdown alarm (“E01”) occurs in advance even when the battery voltage seems to be OK</p>	<p>Make sure you are measuring the voltage directly at the DC-Input terminals of the unit so as to check the possible voltage drop between the battery posts and the unit input terminals</p>	<p>Excessive voltage drop in between the battery bank and the inverter, due to high resistance of the DC wires, battery disconnect switch, fuse or DC breaker if any. Make sure to use the recommended wire’s gauge and length. Try to use fuses (or DC breakers) with very low voltage drop (i.e. ANL type fuses, etc.)</p>
	<p>Battery bank with high internal resistance, resulting in a voltage drop proportional to the DC current draw from the unit.</p>	<p>Too much battery voltage drop due to excessive drawing current in relation to the battery bank capacity. Increase the battery bank capacity (i.e. adding more batteries in parallel) and/or reduce the load being fed by the inverter</p> <p>Battery damaged and not able to keep a good state of charge. Replace the battery (or batteries)</p>
	<p></p>	<p>This is normal condition. The E05 warning and then follow by the E01 shutdown occur while the battery bank is getting discharged. Charge the battery bank.</p>
	<p>Make sure to measure the battery voltage just before the “E01” battery under-voltage shutdown in battery (inverter) mode occurs and compare it with the corresponding voltage threshold in the specifications table. (allow +/- 5% of tolerance)</p>	<p>Just after the E01 occurs, the battery voltage increase rapidly since the battery is not under load condition after the inverter shutdown. This is normal in all the battery banks and can confuse the user thinking the under-voltage shutdown that triggers the E02 alarm occurs very in advance at higher voltage thresholds than the ones specified.</p>
<p>The E05 warning and E01 shutdown alarm occurs well in advance due to the “SdH” setting</p>	<p>If you want to extend the run time of the battery bank as most as possible without the need to keep enough battery state of charge for engine cranking purposes, make sure to set the under-voltage shutdown threshold to low values setting (“SdL” - factory default setting) other than the “SdH”.</p>	

Problem	Possible Cause/Condition	Solution
The display doesn't work as expected (no display or showing "888") and the operability of the unit may be affected	Some loosed contact or pin-out problems in the RJ12 detachable display panel cable	A short (7") RJ12 cable is used when the detachable display panel is mounted on the unit (factory default). Alternatively a long RJ12 cable is provided for installing the display panel up to 25 ft. away. Swap the cable you are using with the other one and check if it makes some difference.
		Check the pin-to-pin conductivity of the cable and the corresponding pin-out as shown in "Appendix II"
	Excessive EMI/RFI interference (electromagnetic induction or electromagnetic radiation) emitted from an external source	Avoid running the cable very close to motors, power contactors/relays, ballasts, transformers, or high voltage devices. In high noisy environments consider using metal conduits or a shielded cable grounded at one end and/or reduce cable length

7. SPECIFICATIONS

Note: The specifications are subject to change without notices.

<i>SINE WAVE INVERTER 12/3000 - 230V</i>	
AC Output Waveform	Sinewave (<3% THD)
Nominal DC Input Voltage	12.5 VDC
No Load battery draw	< 1.5 ADC
DC Input Voltage operating range	10.5 – 15.5 VDC
Under Voltage Alarm	11.0/12.1 VDC
Under Voltage Alarm Recovery	11.3/12.3 VDC
Under Voltage Shutdown	10.5/11.8 VDC
Under Voltage Shutdown Recovery	12.0/12.6 VDC
Over Voltage Shutdown	15.5 VDC
USB Port	5V, 2100 mA
Transfer Time	< 30 ms
Display Panel Port	RJ12 (6 pins)
Inverter Mode	Input Voltage, Output Power
Operating Temperature	0°C to 40°C (32°F to 104°F)
Storage Temperature	-20°C to 60°C (-4°F to 140°F)
Relative Humidity	5-90% noncondensing
Operating Altitude	Up to 9,843ft (3000m) above sea level

8. WARRANTY

Two Years Limited Warranty

The limited warranty program is the only one that applies to this unit, and it sets forth all the responsibilities of WhisperPower. There is no other warranty, other than those described herein. Any implied warranty of merchantability or fitness for a particular purpose on this unit is limited in duration to the duration of this warranty.

This unit is warranted, to the original purchaser only, to be free of defects in materials and workmanship for two year from the date of purchase without additional charge. The warranty does not extend to subsequent purchasers or users. Manufacturer will not be responsible for any amount of damage in excess of the retail purchase price of the unit under any circumstances. Incidental and consequential damages are specifically excluded from coverage under this warranty. This unit is not intended for commercial use. This warranty does not apply to damage to units from misuse or incorrect installation/connection. Misuse includes wiring or connecting to improper polarity power sources

Limitations:

This warranty does not cover accessories, such as adapters and batteries, damage or defects result from normal wear and tear (including chips, scratches, abrasions, discoloration or fading due to usage or exposure to sunlight), accidents, damage during shipping to our service facility, alterations, unauthorized use or repair, neglect, misuse, abuse, failure to follow instructions for care and maintenance, fire and flood.

Return/Repair Policy:

If you are experiencing any problems with your unit, please contact our customer service department at sales@whisperpower.com or Phone +31 (0) 512 571 550 before returning product to retail store. After speaking to a customer service representative, if products are deemed non-working or malfunctioning, the product may be returned to the purchasing store within 30 days of original purchase. Any defective unit that is returned to manufacturer within 30 days of the date of purchase will be replaced free of charge.

If such a unit is returned more than 30 days but less than one year from the purchase date, manufacturer will repair the unit or, at its option, replace it, free of charge. If the unit is repaired, new or reconditioned replacement parts may be used, at manufacturer's option. A unit may be replaced with a new or reconditioned unit of the same or comparable design. The repaired or replaced unit will then be warranted under these terms for the remainder of the warranty period. The customer is responsible for the shipping charges on all returned items.

9. Certificate of conformity

EC Council Directive 2004/108/EC
Electromagnetic Compatibility
Registration No.: NTC1310406E

Applicant : Whisperpower
Address : Kelvinlaan 82, 9207 JB Drachten, The Netherlands.

Manufacturer : Green Power Electronic Co., Ltd.
Address : Ju Long Wei, Tian Xin Industrial Estate, HuangJiang Town, Dongguan,
Guangdong Province, China

Factory : Green Power Electronic Co., Ltd.
Address : Ju Long Wei, Tian Xin Industrial Estate, HuangJiang Town, Dongguan,
Guangdong Province, China

E.U.T. : Power Inverter

Brand Name : WhisperPower

Model No. : 61123500 EU-Socket
61123501 UK-Socket



The certificate of conformity is based on an evaluation of a sample of the above mentioned product. Technical report and documentation are at the applicant's disposal. This is to certify that the tested sample is conformity wit hall provisions of Annex 1 of Council Directive 2004/108/EC, in its latest amended version, referred to EMC Directive. The certificate does not imply assessment of the production and does not permit the use of Lab's logo.

Ing. M. Favot

A handwritten signature in black ink, appearing to be 'M. Favot', written over a horizontal line.

CTO, Drachten

APPENDIX I

Setting Mode Flo Chart:

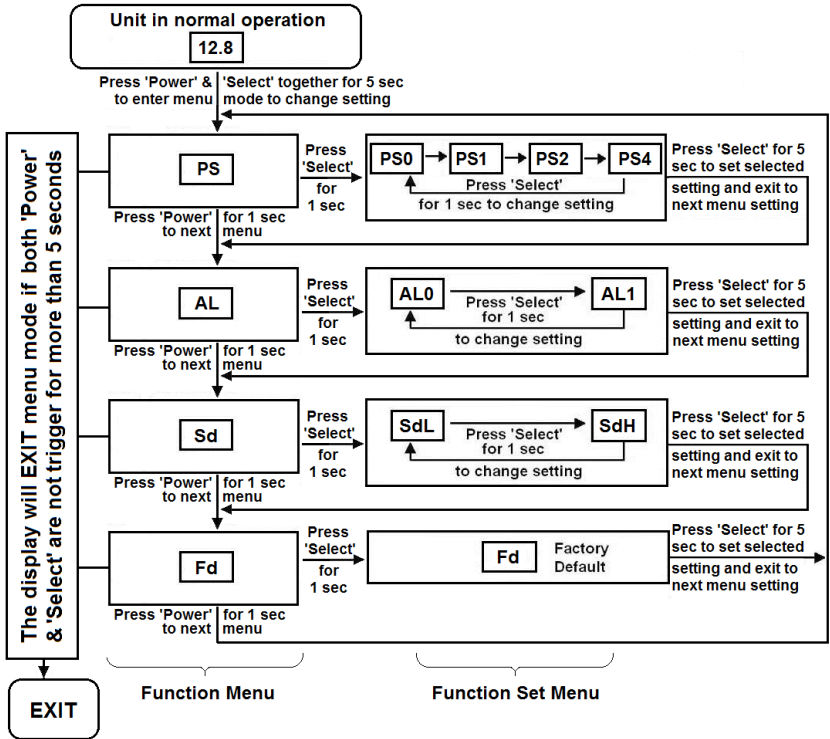

APPENDIX II

Detachable Display Panel Cable:

The display panel is detachable and can be installed away from the unit, using the provided 25' RJ12 cable. You would need to remove the two screws indicated below. Even though the unit can operate with the cable plugged in whatever direction, we suggest plugging the end with the ferrite bead EMI/RFI filter into the main unit.

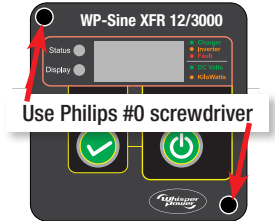

The RJ12 "rollover" cable have 6 wires with the following pin-out:

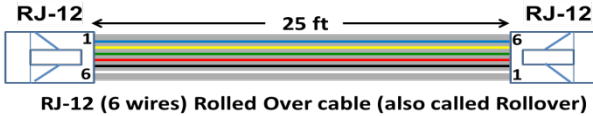

Sales outlets in more than 50 countries
www.whisperpower.com



Generating Confidence

WhisperPower BV | Kelvinlaan 82 | 9207 JB Drachten | The Netherlands

Tel: +31 (0) 512 571 550 | E-mail: sales@whisperpower.com | **[whisperpower.com](http://www.whisperpower.com)**